



Single-pass, two-color printing offers benefits beyond your expectations

Digital duplicator

**2** Color Printing Compatible

**RISO**

**MF 9350**

A3/150 ppm/600 x 600 dpi/Full-color LCD touch panel/  
Versatile connectivity

## High-quality two-color printing makes RISO your ideal partner

RISO is renowned globally for the reliability of its digital duplicators. It is the only company in the world that offers two-color digital duplicators, and is now proud to introduce its most advanced two-color model yet. The MF9350 sets a new gold standard for productivity, cost performance, image quality and operability. Its two-drum layout makes two-color printing faster and easier than ever, with versatile options that are suitable even for small-volume print runs.





**DOUBLE IMPACT:**  
**Two-color** printing with  
**600x600 dpi** resolution



**EASY TWO-COLOR PRINTING**  
**OPERATION:**  
Intuitive interface for single-pass printing

**HIGH PRODUCTIVITY:**  
**150** ppm high-speed printing



**RISO MF 9350**



“We don’t need an expensive full-color printer, but we want well-defined, impressive printouts in two colors...”

## RISO MF series comes with dual drums, offering high-speed, two-color printing with a professional-looking finish.



### Single-pass process for high-speed, two-color printing

RISO MF series employs a single-pass layout, for faster and more efficient two-color printing. Unlike using single-color digital duplicators for two-color output, there’s no need to wait for ink to dry, reinsert paper or change drums.

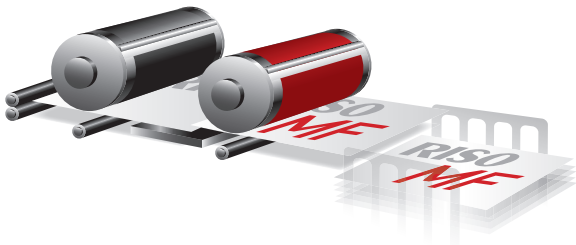

### Two colors to create impressive photo images and enrich your communication

RISO MF series lets you communicate your ideas quickly, beautifully, and usefully. Photos and illustrations can be reproduced with more-defined colors to enhance your power of expression.



### Easier master-making with improved color separation function **NEW**

The MF series makes it simple to create conventional two-color masters (Color Separation, Specified Area, Separation Sheet, Color Editor), but its color separation function has also been greatly improved (available only for scanned documents). Just scan your originals, and you can use the touch panel to specify which areas should be in which color. Color separations can be selected from red/black, green/black, blue/black, warm/cool, and chromatic/achromatic. What’s more, sections of an original document that would previously often have been misjudged regarding the color can now be correctly reproduced.

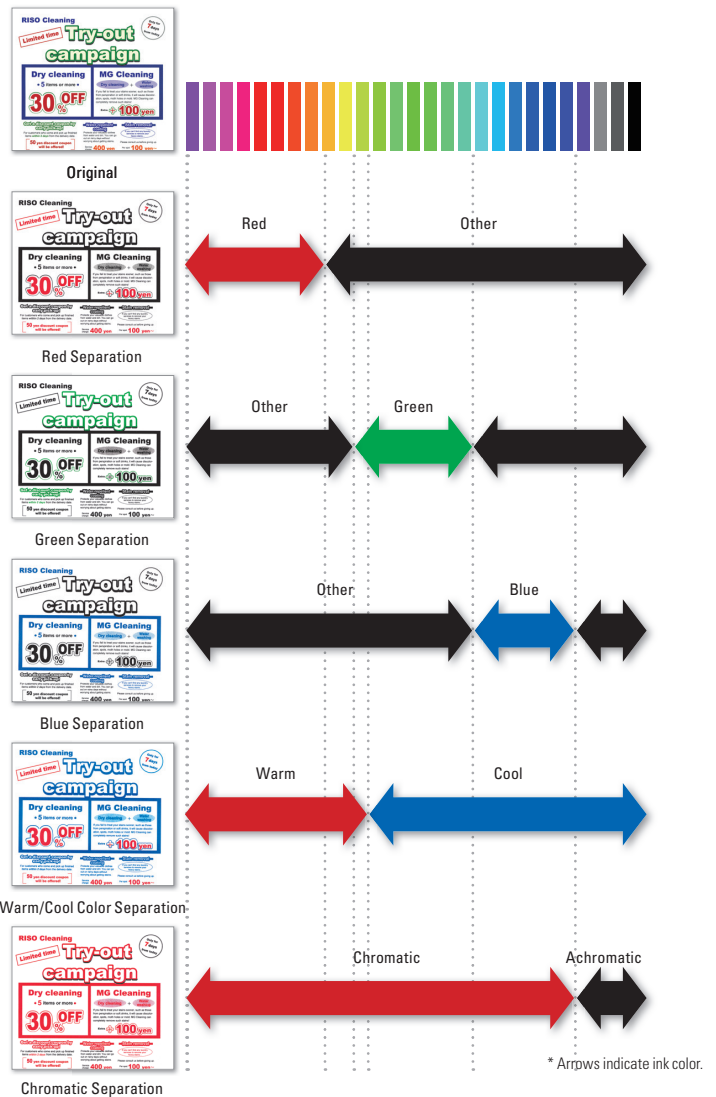



“For better visibility, we don’t want to compromise the beauty of the finish...”

# RISO offers outstanding image quality, providing better images and text with details and smooth gradations.

## Image data processing raises the bar for 600x600 dpi scanning and printing

This achieves sharp and clear output with the highest image quality.

### Enhanced features for clearer output

#### High scanning quality **NEW**

The newly designed scanner attains smooth tonal gradation even with photo images.

- Reduced blown-out highlights via equalized dot description

#### Improved image-processing function **Improved**

Decreases image deterioration through improved image processing, delivering clearer output.

- Minimizes blocked-up shadows through enhanced gamma correction
- Sharp outlines with contour enhancement achieved

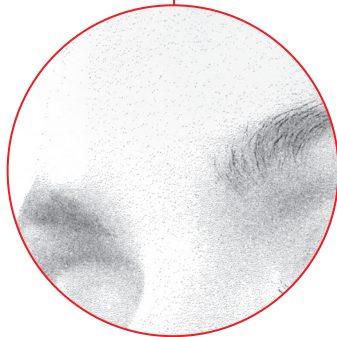
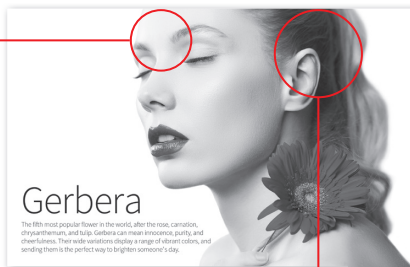

Smother tonal gradations

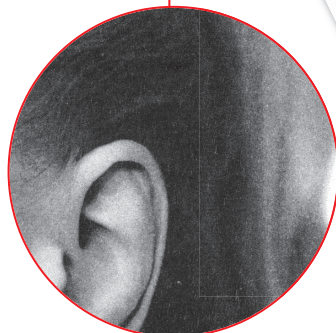

Precise reproduction

## Ink color variations

21 standard colors, 50 custom colors and special order-made colors are available. A wide range of printing colors can meet the needs of a variety of print jobs.

Red	Bright Red	RISO-Marine Red	Burgundy	Brown	Yellow	Green
Teal	Blue	Medium Blue	RISO-Fed. Blue	Purple	Flat Gold	Orange
Crimson	Hunter Green	Gray	Light Gray	Fluorescent Pink	Fluores. Orange	Gold

[Custom colors]



## Upgraded high-definition masters: RISO MASTER F TYPE HG

More precise master copies can be made for reproducing subtle color gradations, clear photo images and even text written in pencil.

## Other various functions for optimum output

- Auto base control
- Tone smooth function
- Four image-processing modes: Line, Photo, Duo, and Pencil



“I wonder if we need a professional operator for such digital duplicators...”

# RISO enables simple operation for anyone through its easy-to-master panel and interface design.



## Redesigned, full-color control panel **Improved**

New, easy-to-use control panel provides intuitive operation. Functions for printing, copying, scanning and managing data are all at your fingertips, logically arranged for intuitive operation on a large 7-inch color LCD touch screen.

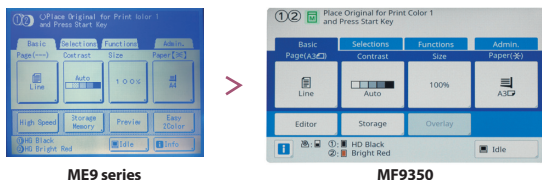

ME9 series

MF9350

## Various printing approaches

The MF series offers various ways of printing, depending on your specific requirements.

- Standard equipment of PC-I/F
- Direct printing from a USB flash drive
- General SD card compatible for data storage



## Print Preview **Improved**

Scanned documents can be viewed and edited on the LCD panel. This is convenient for confirming the output and avoiding printing errors.

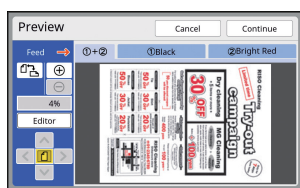

## RISO console

The total management system improves convenience by integrating applications in one place. Product, consumables and system information can all be checked easily on your PC.

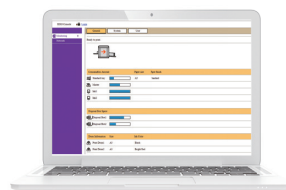

## Preview and Edit to ensure the desired printing result

Using the printer driver installed on your PC, you can assign colors of your choice to documents when printing in two colors by clicking on the Preview and Edit feature box on the PC screen.

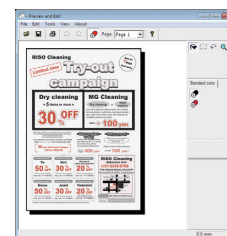

## Usage report

The MF series provides RISO Copy Count Viewer for counting users' printouts, useful for understanding expenses and usage restriction. The aggregate results are available via printout, USB flash drive or email.

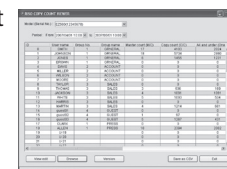



“Since print volume is normally very large, time and costs are major concerns...”

## RISO offers outstanding productivity through high speed and low cost even for a wide variety of short-run prints.



### High-speed, two-color printing at 150 ppm

Achieving 1000 pages printed in approx. 7 minutes, this surprisingly rapid rate will efficiently support your heavy paperwork requirements.



### Quick Master Making mode **NEW**

A new function, Quick Master Making mode, shortens the master-making time while still maintaining high image quality.

### Heavy-load paper feeding

The paper trays have a capacity of 1000 sheets\* for both feeding and receiving, which ensures uninterrupted printing over a longer period.

\*When using the following weight of paper: 64gsm to 80gsm



### Versatile paper handling capability

The MF series plays multiple roles, accepting a wide range of paper types such as recycled paper, coarse paper, cards and envelopes.

### Overwhelmingly economical print costs

The MF series makes prints from a master. As a result, the more pages generated from each master the lower the cost per print, making it highly economical for medium- to high-volume printing.

Print quantity and cost per print

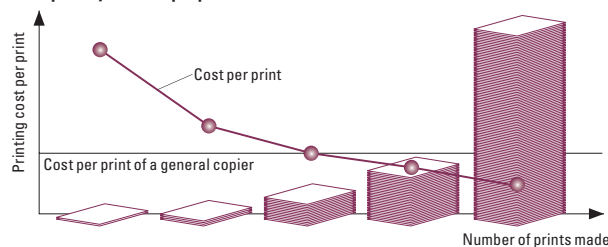

“The environment is highly considered...”

## RISO strongly cares about global environmental issues as well.

### Energy Saving

Energy system with low power consumption. The MF series consumes 1/10th the energy, compared with ENERGY STAR® guidelines.

\* ENERGY STAR qualified and RoHS certified  
\* Complies with the ErP directive in Europe



### Rice bran oil ink **NEW**

The rice bran oil ink contributes to environment sustainability. Rice bran, which would be otherwise wasted, is a raw material with no VOCs, so after the oil is extracted for the ink. It can subsequently be used as fertilizer or animal feed.

### Dimensions

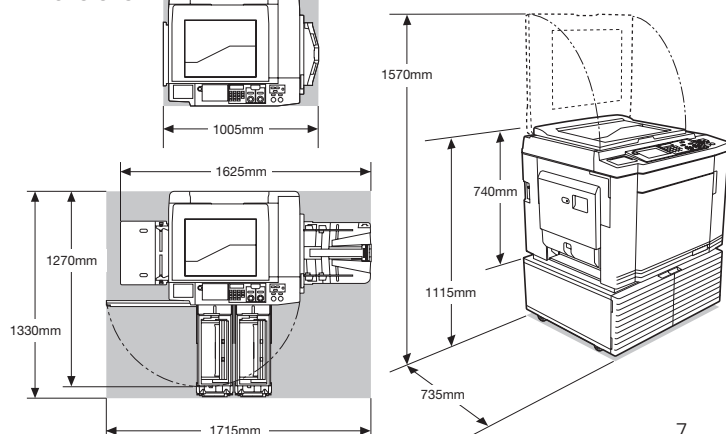



## Optional Accessories

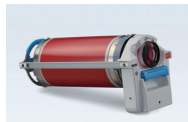

RISO MF/SF Drum

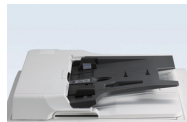

RISO Auto Document Feeder VII



Job Separator IV; NIII



RISO Controller IS300



Card Feed Kit

Compatible with paper weight 100 gsm-400 gsm.  
\*Please contact a RISO sales executive for the kinds of paper that may be used.



Envelope Feeder

Compatible with paper weights 50 gsm to 120 gsm.  
\*Please contact a RISO sales executive for the kinds of paper that may be used.



RISO DRUM STORAGE STAND III 2 COLOR

Deluxe and with doors for convenient storage with a neat appearance.



RISO STAND N TYPE III 2 COLOR

Sturdy open-front stand also offers convenient storage of consumables.

- IC Card Reader Activation Kit RG
- Wide Stacking Tray (Allows use of paper up to 555 mm in long edge.)
- RISO Printer driver for Macintosh

## Specifications

<b>Master Making/Printing Methods</b>		High-speed digital master-making/Fully automatic printing
<b>Original type</b>		Book or Sheet
<b>Master Making Time<sup>1)</sup></b> (A4 short edge feed)	<b>Quick Master Making Mode</b>	Dual color print: approx. 53 seconds Mono color print with drum (cylinder) 1: approx. 22 seconds Mono color print with drum (cylinder) 2: approx. 32 seconds
	<b>Normal Master Making Mode</b>	Dual color print: approx. 57 seconds Mono color print with drum (cylinder) 1: approx. 24 seconds Mono color print with drum (cylinder) 2: approx. 34 seconds
<b>Resolution</b>	<b>Scanning</b>	600 dpi × 600 dpi
	<b>Printing</b>	600 dpi × 600 dpi, Quick Master Making Mode: 600 dpi × 400 dpi
<b>Maximum Scanning Area</b>		297 mm × 432 mm
<b>Print paper weight</b>		46 gsm to 210 gsm
<b>Print Paper Size<sup>2)</sup></b>	<b>Dual color print</b>	Standard size: B5, A4, B4, A3, Foolscap Custom size: 100 mm × 246 mm to 320 mm × 432 mm
	<b>Mono color print with drum (cylinder) 1</b>	Standard size: B5, B5 (long edge feed), A4, A4 (long edge feed), B4, A3, Foolscap Custom size: 100 mm × 148 mm to 320 mm × 432 mm
	<b>Mono color print with drum (cylinder) 2 (when drum (cylinder) 1 is set in place)</b>	Standard size: B5, A4, B4, A3, Foolscap Custom size: 100 mm × 246 mm to 320 mm × 432 mm
	<b>Mono color print with drum (cylinder) 2 (when drum (cylinder) 1 is removed)<sup>3)</sup></b>	Standard size: B5, A4, B4, A3, Foolscap Custom size: 100 mm × 315 mm to 320 mm × 432 mm
<b>Maximum Printing Area</b>		291 mm × 413 mm
<b>Paper Feed Tray Stacking Capacity</b>		1000 sheets <sup>4)</sup> (stacking height of 110 mm or less)
<b>Paper Receiving Tray Stacking Capacity</b>		1000 sheets <sup>4)</sup> (stacking height of 110 mm or less)
<b>Print Speed</b>		6 levels: 60, 80, 100, 110, 120, and 150 (High Speed <sup>5)</sup> ) sheets per minute
<b>Print Position Adjustment</b>		Horizontal: ±15 mm Vertical: ±10 mm
<b>Image Processing Mode</b>		Line, Photo (Standard/Portrait), Duo (Standard/Line/Photo/Shadow off), Pencil (Darker/Lighter)
<b>Print Reproduction Ratio</b>		Zoom (50% to 200%), Free, 100% reproduction ratio, Margin+ (90% to 99%), Enlargement (163%, 141%, 122%, 116%), Reduction (87%, 82%, 71%, 61%)
<b>User Interface</b>		Color touch panel
<b>Functions</b>		Image, Contrast, Size, Paper Size Detection, D-Feed Check, Dot Process, Contrast Adj, Tone Curve, Layout, Multi-Up Print, 2 Up, Book Shadow, Top Margin Adj., Binding Margin Adj., Max. Scan, Ink Saving, Quick Master Making, Preview, ADF Semi-Auto <sup>6)</sup> , Storage, Overlay, Stamp, Print Speed Adjustment, Print Density Adjustment, Print Position Adjustment, Interval, Renew Page, Auto Page Renewal, OneSide MasterMake, Rotate, Special Paper Ctrl, Output reversal, Scanning Side -ADF <sup>7)</sup> , Paper Memory Print, Separation, Recommendation Preview, Color, Program, Job Separation <sup>8)</sup> , Slip sheet sorting, Job Memory, Reservation, Editor, Idling Action, Confidential, My Direct Access, Meter Display, ID Counter Report, Proof Copy, Direct Printing, USB Job List, Scanning Mode, Admin., Auto Sleep, Auto Power-OFF, Power-OFF Schedule, Protect, RISO iQuality System
<b>PC Interface</b>		USB2.0, Ethernet: 100BASE-TX/10BASE-T
<b>Ink Supply</b>		Full automatic (1000 ml/cartridge)
<b>Master Supply/Disposal</b>		Full automatic A3 approx. 220 sheets per roll/Disposal capacity: approx. 80 sheets
<b>Power Source</b>		MF9350E: AC 220-240 V, 50-60 Hz <3.0 A>, MF9350A (For Korea: AC 220 V, 60 Hz <3.0 A>-, For other countries: AC 100-240 V, 50-60 Hz <7.3-3.0 A>)
<b>Power Consumption</b>	<b>Standard</b>	Max. 630 W (AC 100-120V), 580 W (AC 220-240V), Ready: 50 W or lower, Sleep: (Standard) 5 W or lower, (Low) 0.5 W or lower, Power-OFF: 0.5 W or lower
	<b>Optional Accessories Connected<sup>8)</sup></b>	Max. 630 W (AC 100-120V), 580 W (AC 220-240V), Ready: 53 W or lower, Sleep: (Standard) 10 W or lower, (Low) 1.5 W or lower, Power-OFF: 0.5 W or lower
<b>Dimensions (W×D×H)<sup>9)</sup></b>	<b>In use</b>	1715 mm × 735 mm × 1115 mm
	<b>In storage</b>	1005 mm × 735 mm × 1115 mm
<b>Required Space (W×D×H)</b>		1715 mm × 1330 mm × 1570 mm
<b>Weight<sup>10)</sup></b>		Approx. 164 kg

<sup>1)</sup> Measurement value when set to 100% reproduction ratio. <sup>2)</sup> When the optional Wide Stacking Tray is installed, you can use paper up to a size of 340mm × 555mm by setting [Custom Paper Entry]. <sup>3)</sup> The print position may not be stabilized when a B5 or A4 size sheet is printed in a single color with print drum (cylinder) 2. When printing at [High Speed] and using paper with a horizontal length of less than 364 mm, the print position may not be stabilized. <sup>4)</sup> When using the following weight of paper; 64gsm to 80gsm <sup>5)</sup> If the temperature of the inside of the print drum (cylinder) is less than 15°C, [High Speed] is not usable. In order to use [High Speed] when you print in mono-color mode with print drum (cylinder) 2 while print drum (cylinder) 1 is removed, use paper with a length of 364 mm to 432 mm in the horizontal direction. <sup>6)</sup> Usable when the optional auto document feeder is installed. <sup>7)</sup> Usable when the optional Job Separator is installed. <sup>8)</sup> When all the following optional accessories are installed. Auto Document Feeder, Job Separator and IC Card Reader. <sup>9)</sup> The height includes the dedicated rack. <sup>10)</sup> The weight does not include the ink, master roll, and rack.

Notes: Specifications are subject to change without notice.

## RISO iQualitySystem™



The RISO iQuality mark indicates a RISO product compatible with the RISO iQuality System.



RISO INK F TYPE Color (1000 ml)



RISO MASTER F TYPE HG97  
RISO MASTER F TYPE HD87  
(A3: 220 sheets)



RISO INK F TYPE HD BLACK  
(1000 ml)

● RISO, RISO iQualitySystem and  are trademarks or registered trademarks of RISO KAGAKU CORPORATION in the United States and other countries. Other corporate names and/or trademarks are either registered trademarks or trademarks of each company, respectively. Copyright ©2017 RISO KAGAKU CORPORATION. All rights reserved.



RISO KAGAKU CORPORATION  
5-34-7 Shiba, Minato-ku, Tokyo 108-8385 Japan  
<http://www.riso.com/>

For more details please contact: